



## JOCT354Xt-M4 Series

Rev.A.1.0

### DESCRIPTION:

The products are transistor opto-couplers in a plastic SOP4 package. The device combines an AlGaAs infrared emitting diodes the emitter which is optically coupled to a silicon planar phototransistor detector. With the robust coplanar double mold structure, the device provides the most stable isolation feature. The products are widely used in switch mode power supplies, programmable controllers, household appliances and office equipment.



### MAIN FEATURES

- High isolation 3750 VRMS
- Operating temperature range -55°C to 125°C
- RoHS & REACH Compliance
- HBM: H3A; MM: M4; CDM:C3
- CQC approved
- VDE approved
- UL approved

### ABSOLUTE MAXIMUM RATINGS (Temperature=25°C)

Parameter		Symbol	Value	Unit
Input	Forward Current	$I_F$	50	mA
	Peak Forward Current	$I_{FP}$	1	A
	Reverse Voltage	$V_R$	6	V
	Power Dissipation	$P_D$	75	mW
Output	Collector-emitter Voltage	$V_{CEO}$	80	V
	Emitter-collector Voltage	$V_{ECO}$	6	V
	Collector Current	$I_C$	50	mA
	Power Dissipation	$P_C$	150	mW
Total Power Dissipation		$P_{tot}$	225	mW
Isolation Voltage		$V_{iso}$	3750	Vrms
Operating Temperature		$T_{opr}$	-55~+125	
Junction Temperature		$T_j$	135	

Storage Temperature	T <sub>stg</sub>	-55~+125	
Soldering Temperature	T <sub>sol</sub>	260	

NOTE1: 100μs pulse, 100Hz frequency

NOTE2: AC for 1minute, R.H.=40~60%

**ELECTRICAL CHARACTERISTICS** (Temperature=25°C)

Parameter		Symbol	Condition	Min.	Typ.	Max.	Unit
Input	Forward Voltage	V <sub>F</sub>	I <sub>F</sub> =±10mA	-	1.2	1.5	V
	Terminal Capacitance	C <sub>t</sub>	V=0, f=1MHz	-	10	-	pF
Output	Collector-Emitter dark current	I <sub>CEO</sub>	V <sub>CE</sub> =20V, I <sub>F</sub> =0	-	-	100	nA
	Collector-Emitter breakdown voltage	BV <sub>CEO</sub>	I <sub>C</sub> =0.1mA I <sub>F</sub> =0	80	-	-	V
	Emitter-Collector breakdown voltage	BV <sub>ECO</sub>	I <sub>E</sub> =0.1mA I <sub>F</sub> =0	6	-	-	V
Transfer Characteristics	Current transfer ratio	CTR	I <sub>F</sub> =±5mA V <sub>CE</sub> =5V	100	-	400	%
	Collector-Emitter Saturation Voltage	V <sub>CE(sat)</sub>	I <sub>F</sub> =±20mA I <sub>C</sub> =1mA	-	0.07	0.2	V
	Isolation resistance	R <sub>IO</sub>	DC500V 40~60%R.H.	10 <sup>12</sup>	10 <sup>14</sup>	-	Ω
	Floating Capacitance	C <sub>IO</sub>	V=0, f=1MHz	-	0.4	1	pF
	Cut-off Frequency	f <sub>c</sub>	V <sub>CE</sub> =5V, I <sub>C</sub> =2mA R <sub>L</sub> =100Ω, -3dB	-	80	-	kHz
	Rise Time	t <sub>r</sub>	V <sub>CE</sub> =2V, I <sub>C</sub> =2mA R <sub>L</sub> =100Ω	-	4	18	μs
	Fall Time	t <sub>f</sub>		-	5	18	μs
	Response Time	t <sub>on</sub>		-	7	25	μs
t <sub>off</sub>		-		6	25	μs	

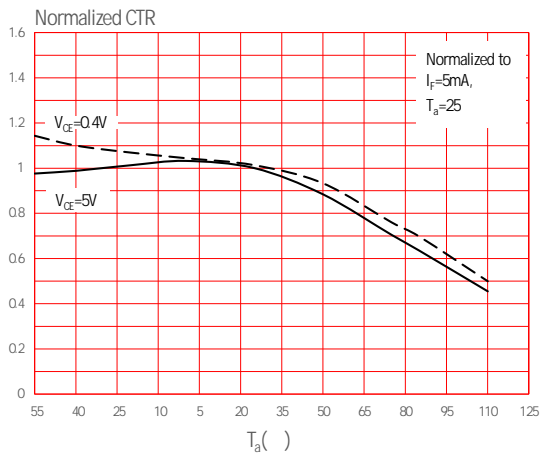
NOTE1: Rank Table of Current Transfer Ratio (Temperature=25°C)

CTR Rank	Min. (%)	Max. (%)	Test Condition
P	200	400	I <sub>F</sub> =±0.5mA, V <sub>CE</sub> =5V
	200	400	I <sub>F</sub> =±5mA, V <sub>CE</sub> =5V
Q	100	300	I <sub>F</sub> =±0.5mA, V <sub>CE</sub> =5V
	100	300	I <sub>F</sub> =±5mA, V <sub>CE</sub> =5V

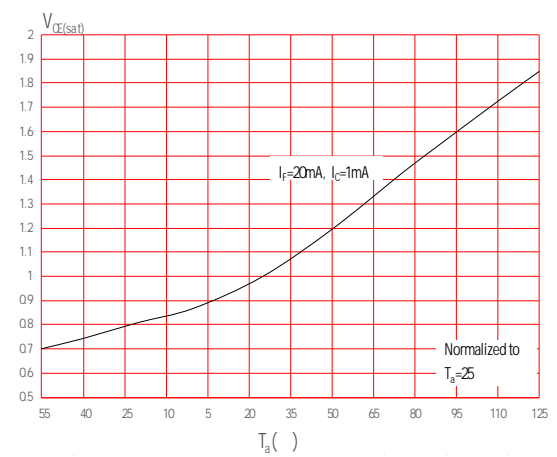




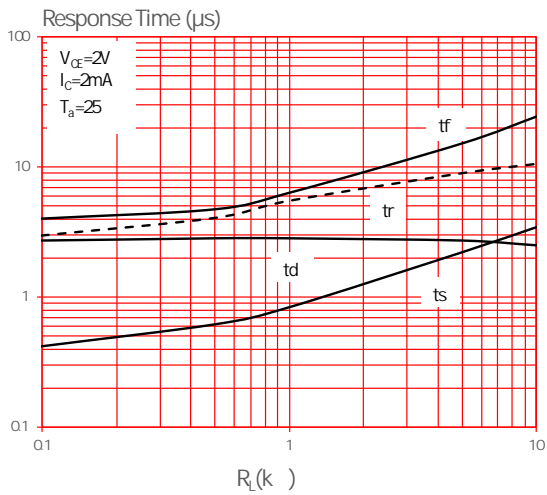
**FIG.7:** Normalized Current Transfer Ratio vs. Ambient Temperature



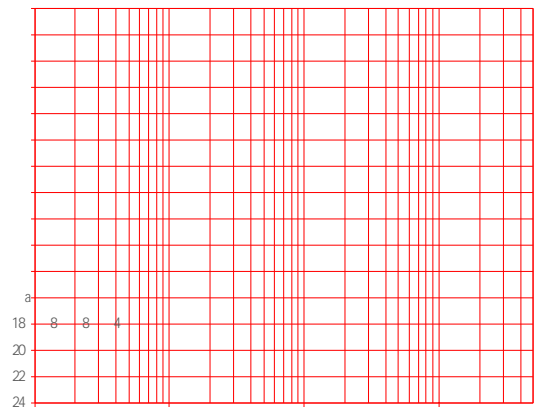
**FIG.8:** Normalized Collector-emitter Saturation Voltage vs. Ambient Temperature



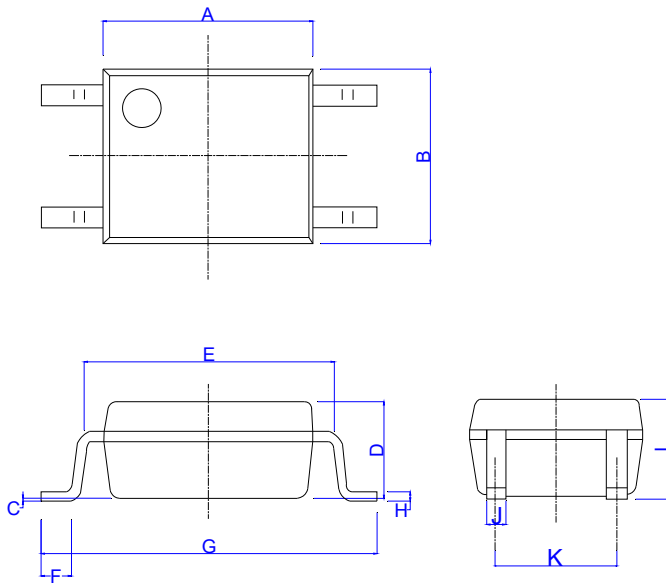
**FIG.9:** Response Time vs. Load Resistance



**FIG.10:** Frequency Response

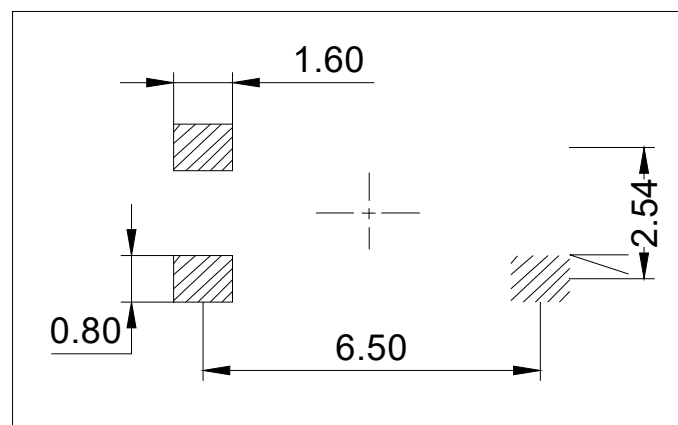


Package Dimension (Unit: mm)



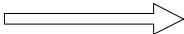
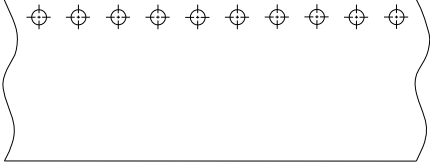
Ref.	Dimensions					
	Millimeters			Inches		
	Min.	Typ.	Max.	Min.	Typ.	Max.
A	4.40		4.80	0.173		0.189
B	3.60		4.20	0.142		0.165
C	0.00		0.20	0.000		0.008
D	1.90		2.30	0.075		0.091
E	5.00		5.60	0.197		0.220
F	0.34		0.94	0.013		0.037
G	6.70		7.30	0.264		0.287
H	0.10		0.30	0.004		0.012
I	2.00		2.40	0.079		0.094
J	0.25		0.55	0.010		0.022
K	2.29		2.79	0.090		0.110

RECOMMENDED SOLDER MASK (Dimensions in mm unless otherwise stated)

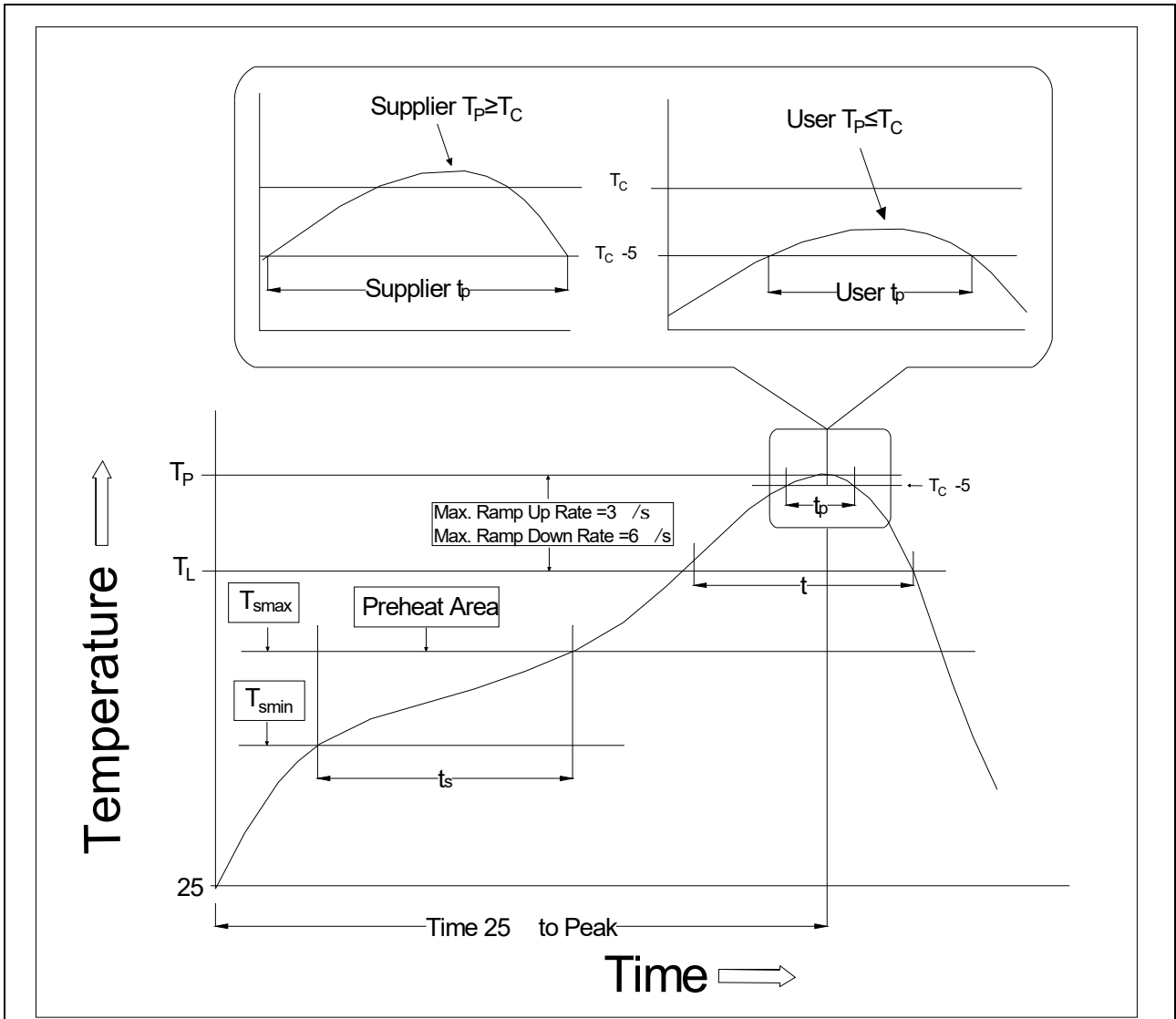


CARRIER TAPE SPECIFICATIONS (Dimensions in mm unless otherwise stated)

Option None



REFLOW INFORMATION




Profile Feature	Sn-Pb Assembly Profile	Pb-Free Assembly Profile
Temperature Min. (T <sub>smin</sub> )	100	150
Temperature Max. (T <sub>smax</sub> )	150	200
Time (t <sub>s</sub> ) from (T <sub>smin</sub> to T <sub>smax</sub> )	60-120 seconds	60-120 seconds
Ramp-up Rate (t <sub>L</sub> to t <sub>P</sub> )	3 °C/second max.	3 °C/second max.
Liquidus Temperature (T <sub>L</sub> )	183	217
Time (t <sub>L</sub> ) Maintained Above (T <sub>L</sub> )	60-150 seconds	60-150 seconds
Peak Body Package Temperature	235 +0 /-5	260 +0 /-5
Time (t <sub>P</sub> ) within 5 °C of 260	20 seconds	30 seconds
Ramp-down Rate (T <sub>P</sub> to T <sub>L</sub> )	6 °C/second max.	6 °C/second max.
Time 25 °C to Peak Temperature	6 minutes max.	8 minutes max.

Note:

1. Reflow soldering is recommended at the temperatures and times shown, no more than three times.
2. Avoid direct contact between the epoxy body and any tools or surfaces exceeding its maximum storage temperature.
3. Application of pressure on the epoxy body is prohibited at elevated temperatures. In specific scenarios, any applied force must not exceed 2.5N.
4. Ensure the component has cooled to ambient temperature before proceeding with any subsequent manufacturing steps.
5. The component has a shelf life of one year when stored under standard conditions.
6. Recommend storage Temp.: 0~40°C;  
Recommend storage humidity: <60%;  
MSL level: MSL 1

Information furnished in this document is believed to be accurate and reliable. However, Jiangsu JieJie Microelectronics Co., Ltd. assumes no responsibility for the consequences of use without consideration for such information nor use beyond it. Information mentioned in this document is subject to change without notice, apart from that when an agreement is signed, Jiangsu JieJie complies with the agreement.

Products and information provided in this document have no infringement of patents. Jiangsu JieJie assumes no responsibility for any infringement of other rights of third parties which may result from the use of such products and information. This document supersedes and replaces all information previously supplied.

 is a registered trademark of Jiangsu JieJie Microelectronics Co., Ltd.

Copyright © 2026 Jiangsu JieJie Microelectronics Co., Ltd. All rights reserved.