

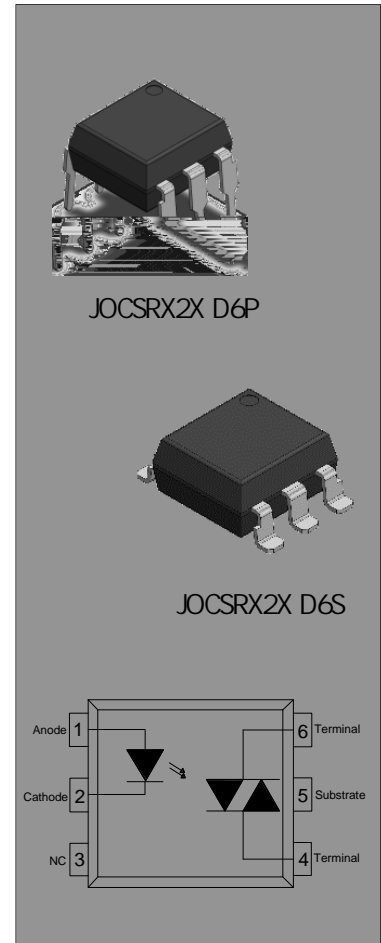

The products are 6-pin thyristor opto-couplers. The device combines an AlGaAs infrared emitting diode as the emitter which is optically coupled to a monolithic silicon random-phase photo triac in a plastic DIP6 package with different lead forming options. With the robust coplanar double mold structure, the device provides the most stable isolation feature. The products are widely used in solenoid/valve controls, lighting controls, motor controls, temperature controls, static AC power switches, solid state relays, interfacing microprocessors up to 265 V_{AC} peripherals.

- High isolation 5000 VRMS
- DC input with random-phase photo triac output
- Operating temperature range -55 to 110
- REACH & RoHS compliance
- HBM: H3A; MM: M4; CDM: C3
- CQC approved
- VDE approved
- UL approved



(Temperature=25°C)

Parameter		Symbol	Value	Unit	
Input	Forward Current	I _F	50	mA	
	Peak Forward Current	I _{FP}	1 ^①	A	
	Reverse Voltage	V _R	6	V	
	Power Dissipation	P _D	75	mW	
Output	Off-state Output Terminal Voltage	V _{OFF}	JOCSR22X	600	V
			JOCSR32X	800	
	Peak On-state Current (100μs pulse, 120 pps)	I _{TP}	2.5	A	
	On-state RMS Current	I _{T(RMS)}	150	mA	
	Peak Repetitive Surge Current (P _w =10 ms)	I _{TSM}	1.5	A	
Output Power Dissipation	P _O	250	mW		

Total Power Dissipation	P_{tot}	325	mW
Isolation Voltage	V_{iso}	5000 ^②	Vrms
Operating Temperature	T_{opr}	-55~110	°C
Junction Temperature	T_j	125	°C
Storage Temperature	T_{stg}	-55~125	°C
Soldering Temperature	T_{sol}	260	°C
Peak pulse voltage ($T_j=25^{\circ}C$; non-repetitive,off-state)	V_{pp}	1	kV

: 100 μ s pulse, 100Hz frequency

: AC for 1minute, R.H.=40~60%

(Temperature=25°C)

Parameter		Symbol	Condition	Min.	Typ.	Max.	Unit
Input	Forward Voltage	V_F	$I_F=10mA$	-	1.2	1.5	V
	Reverse Current	I_R					

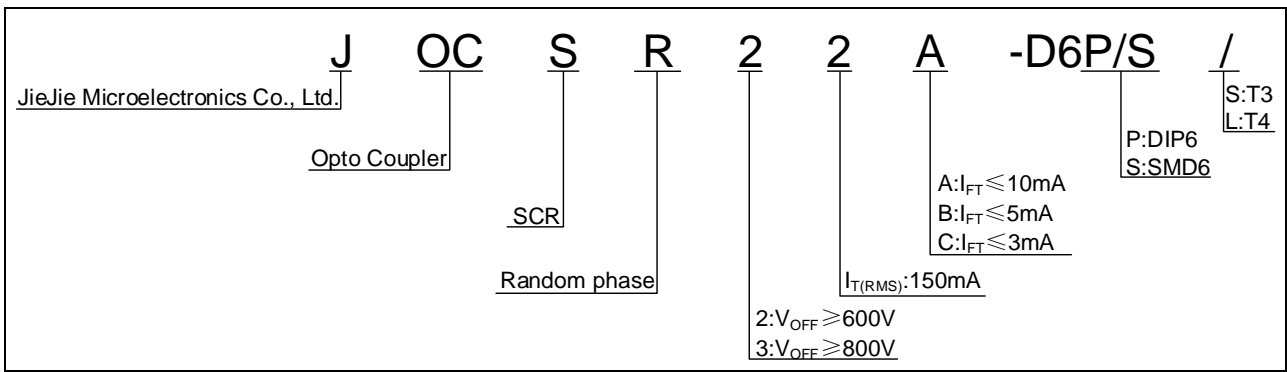

DIP	60 Units/Tube
SMD	1200 Units/Reel

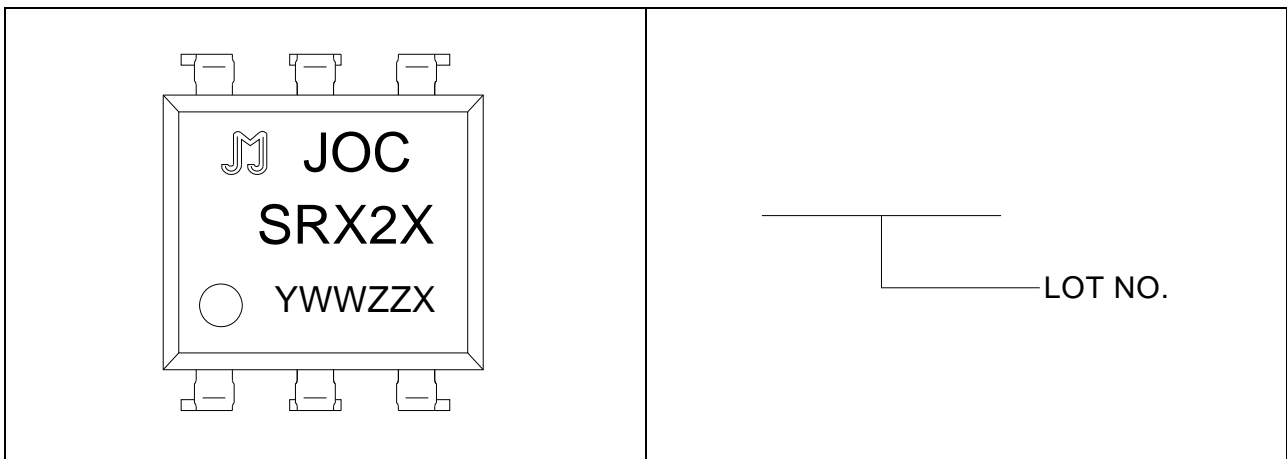

FIG.1: Max. Allowable LED Forward Current vs. Ambient Temperature

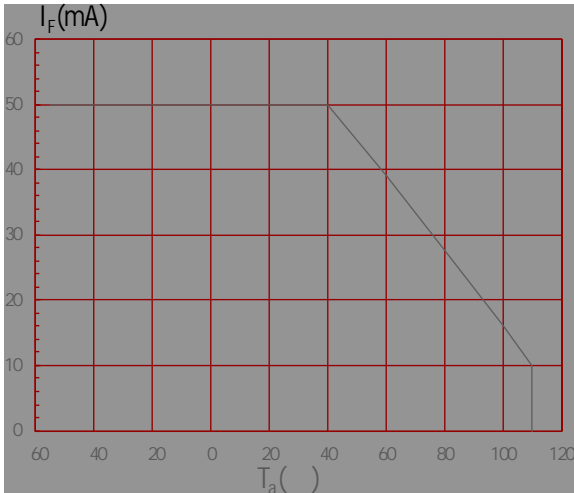

FIG.3: Forward Current vs. Forward Voltage

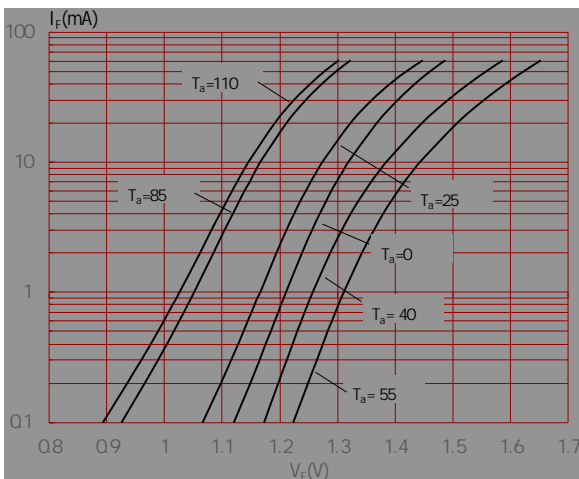

FIG.5: Normalized Off-state Terminal Voltage vs. Ambient Temperature

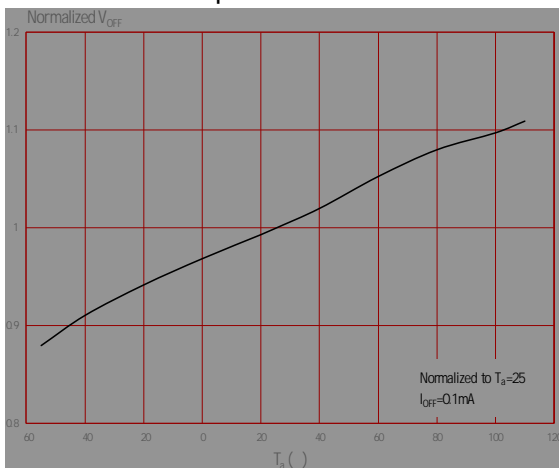

FIG.2: On-state Terminal Current vs. Ambient Temperature

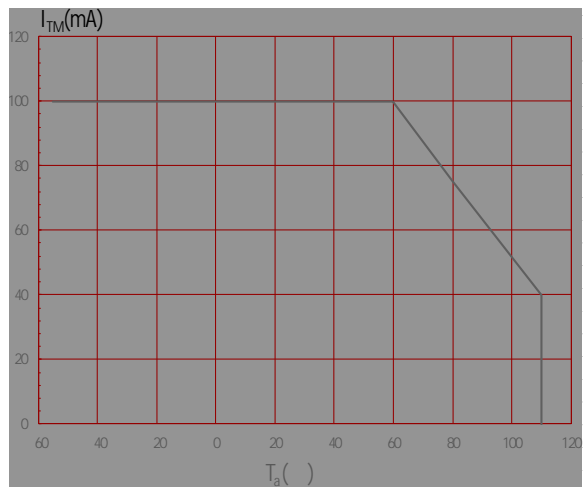

FIG.4: Normalized Off-state Terminal Current vs. Ambient Temperature

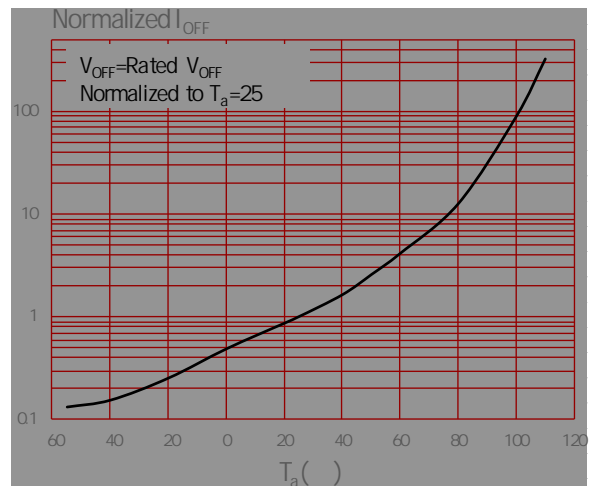

FIG.6: Normalized Trigger Current vs. Ambient Temperature

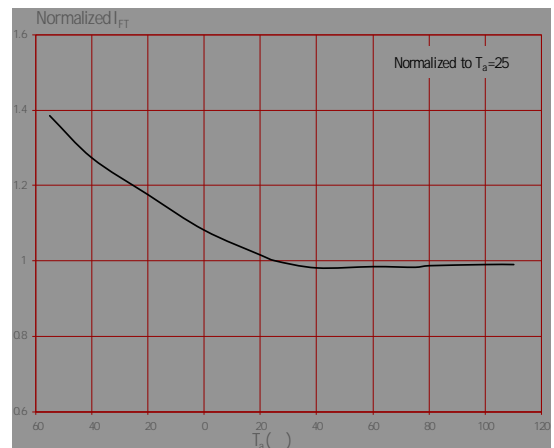

FIG.7: Normalized On-state Terminal Voltage vs. Ambient Temperature

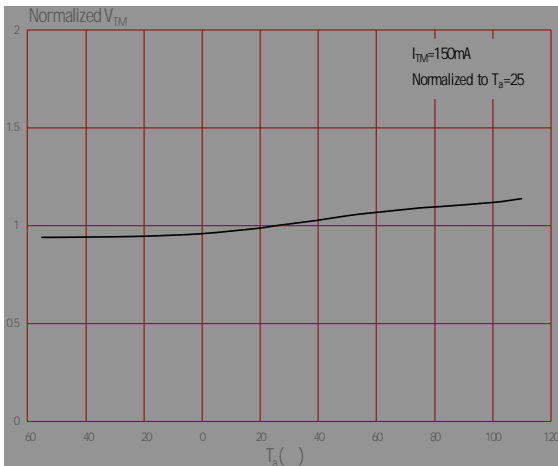

FIG.8: On-state Terminal Voltage vs. On-state Terminal Current

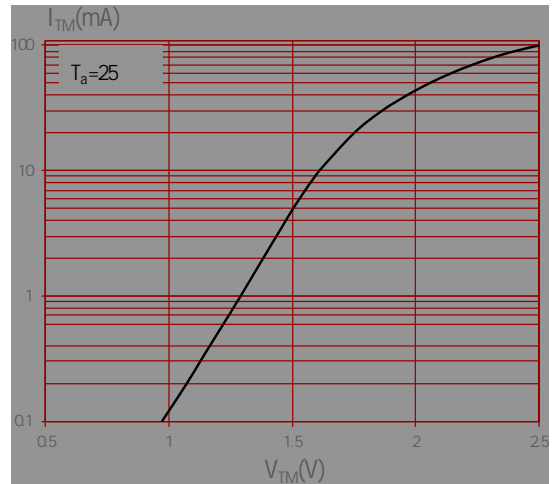

FIG.9: Normalized Holding Current vs. Ambient Temperature

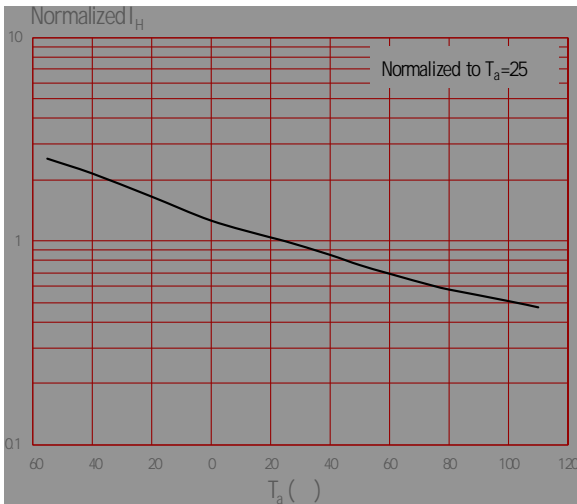

FIG.10: Turn On Time vs. Forward Current

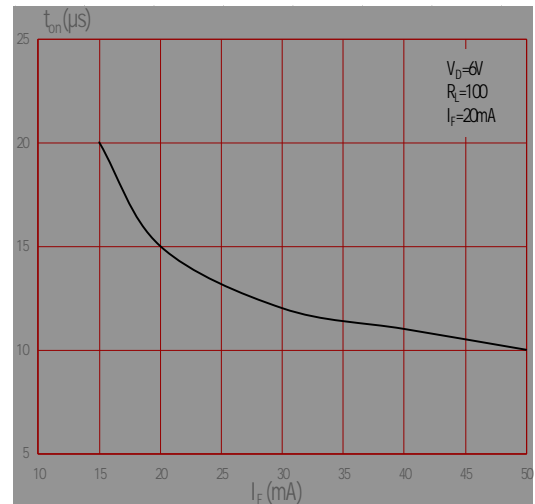

FIG.11: Normalized Turn On Time vs. Ambient Temperature

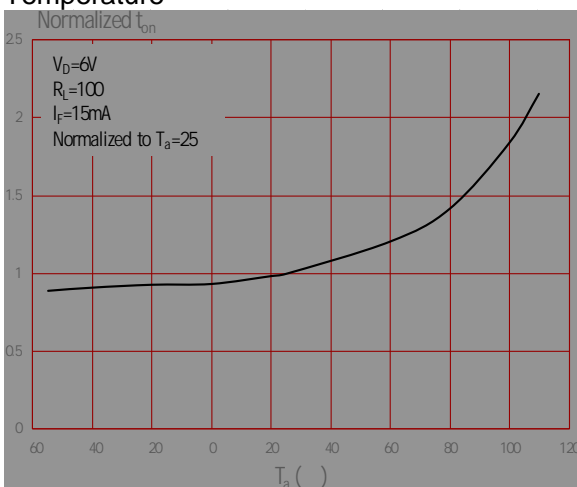

FIG.12: Test Circuits of Turn On Time

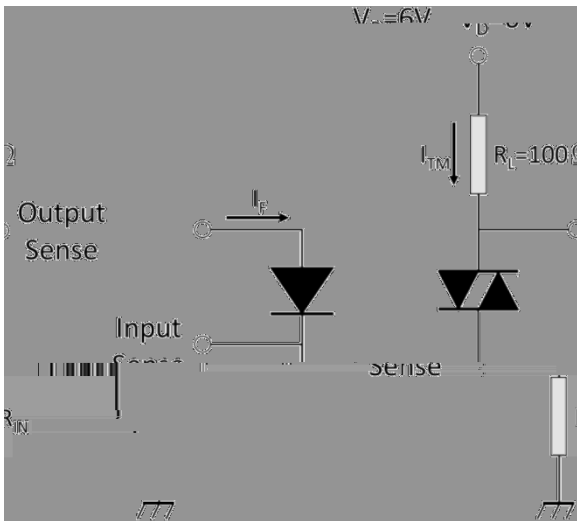

FIG.13: Waveforms of Turn On Time

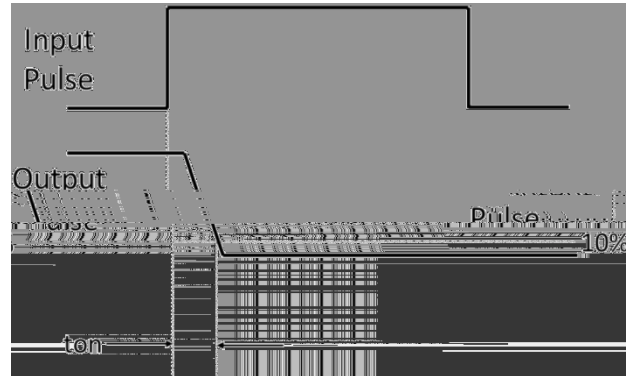

Fig.14: Test Circuits of dV/dt

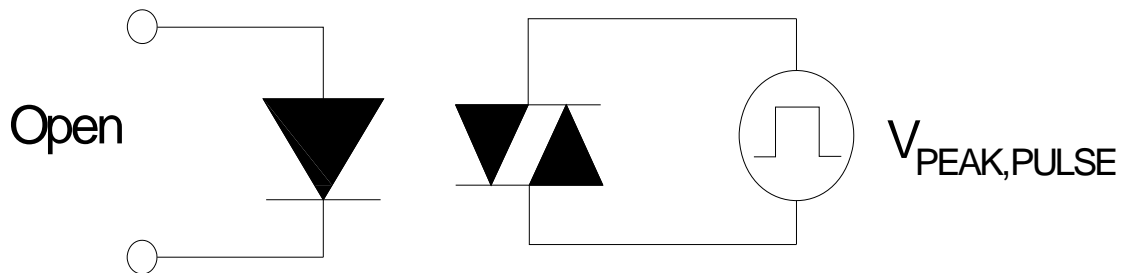

Fig.15: Waveforms of dV/dt

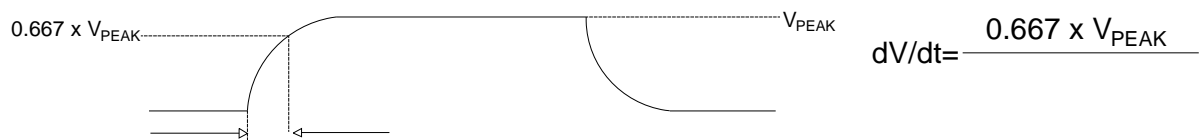
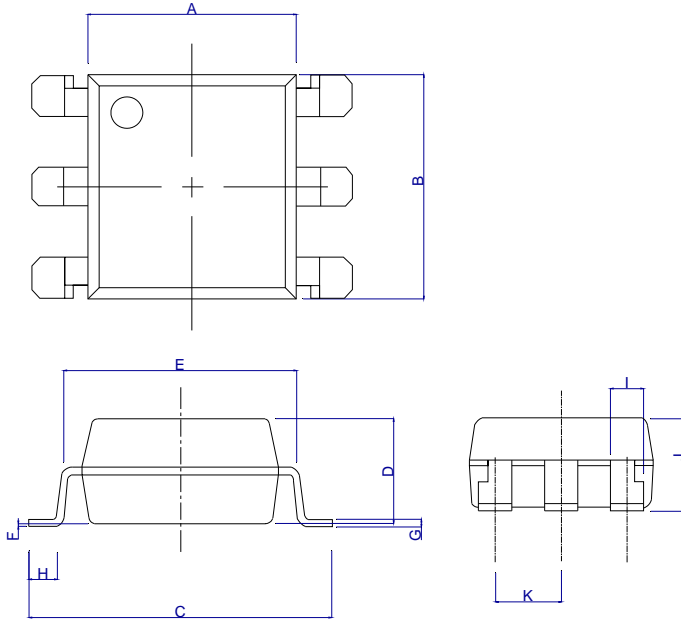

FIG.16: Test circuit for inductive and resistive loads to IEC-61000-4-5 standards



Option SMD Type:



Ref.	Dimensions					
	Millimeters			Inches		
	Min.	Typ.	Max.	Min.	Typ.	Max.
A	6.20		6.60	0.244		0.260
B	6.92		7.32	0.272		0.288
C	9.50		10.50	0.375		0.413
D	3.20		3.60	0.126		0.142
E	7.32		7.92	0.288		0.312
F	0.05		0.35	0.002		0.014
G	0.16		0.36	0.006		0.014
H	0.60		1.40	0.024		0.055
I	0.90		1.50	0.035		0.059
J	3.30		3.90	0.130		0.154
K	2.29		2.79	0.090		0.110

Option SMD

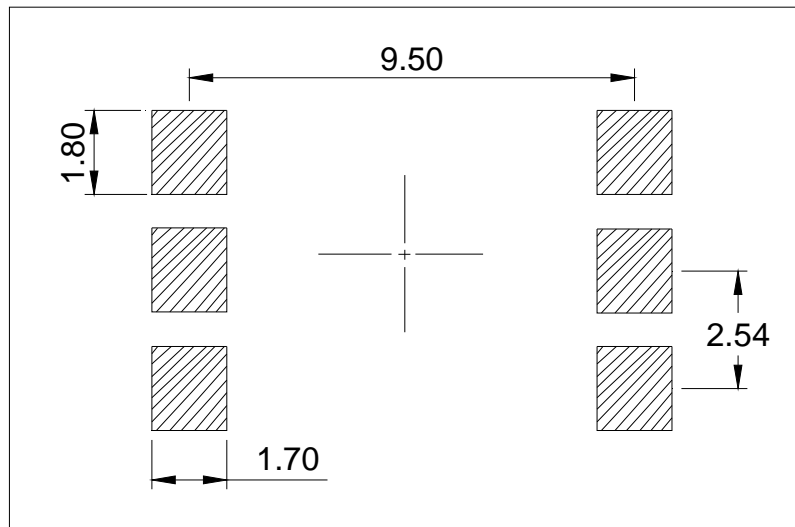

Standard DIP

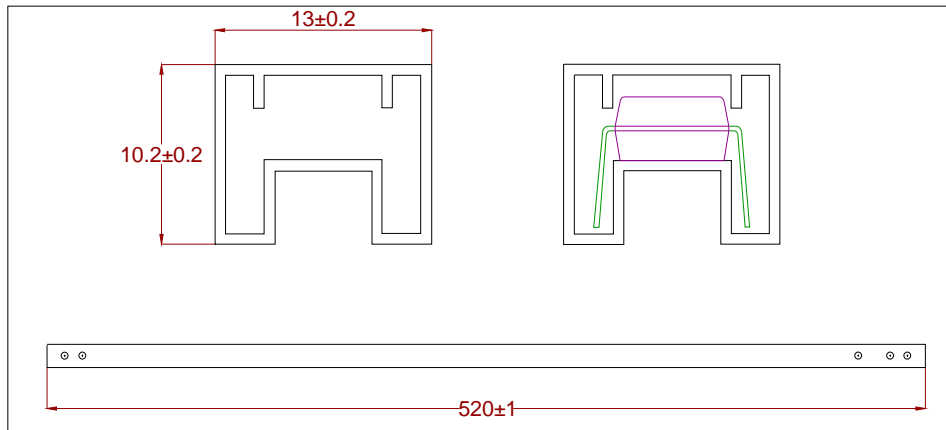

Option S/L

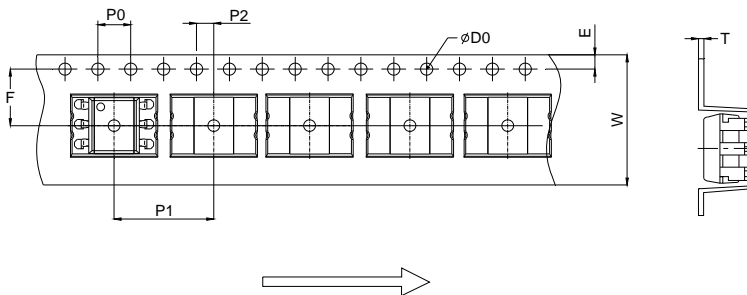

Ref.	Dimensions					
	Millimeters			Inches		
	Min.	Typ.	Max.	Min.	Typ.	Max.
D0		1.50	1.60	0.059	0.063	
P0	3.90	4.00	4.10	0.154	0.157	0.161
P1	11.90	12.00	12.10	0.469	0.472	0.476
P2	1.90	2.00	2.10	0.075	0.079	0.083
E	1.65	1.75	1.85	0.065	0.069	0.073
F	7.40	7.50	7.60	0.291	0.295	0.299
T	0.35	0.40	0.45	0.014	0.016	0.018
W	15.70	16.00	16.30	0.618	0.630	0.642

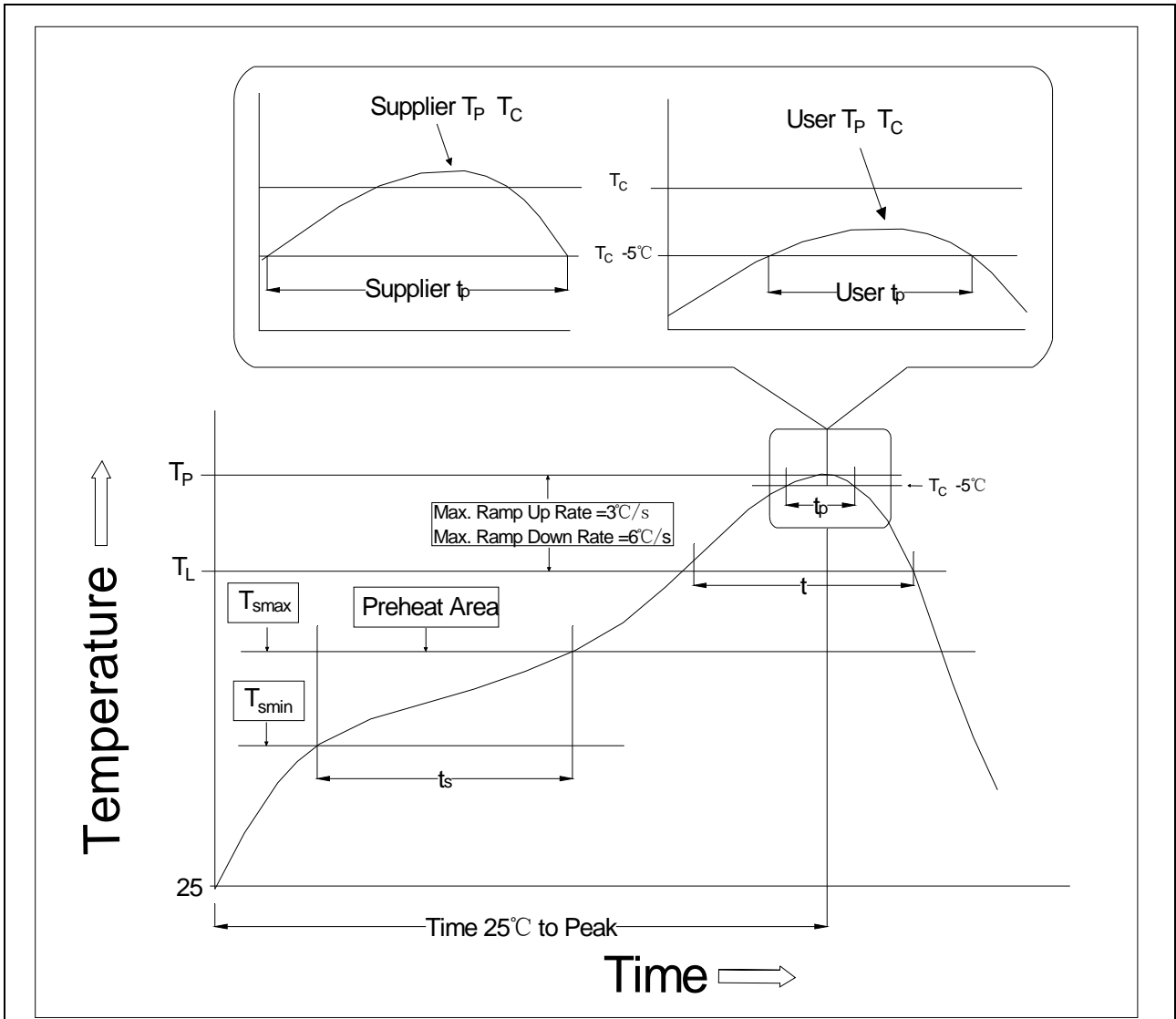

Profile Feature	Sn-Pb Assembly Profile	Pb-Free Assembly Profile
Temperature Min. (T_{smin})	100	150°C
Temperature Max. (T_{smax})	150	200°C
Time (t_s) from (T_{smin} to T_{smax})	60-120 seconds	60-120 seconds
Ramp-up Rate (t_L to t_P)	3°C/second max.	3°C/second max.
Liquidus Temperature (T_L)	183°C	217°C
Time (t_L) Maintained Above (T_L)	60-150 seconds	60-150 seconds
Peak Body Package Temperature	235°C+0°C/-5°C	260°C+0°C/-5°C
Time (t_P) within 5°C of 260°C	20 seconds	30 seconds
Ramp-down Rate (T_P to T_L)	6°C/second max.	6°C/second max.
Time 25°C to Peak Temperature	6 minutes max.	8 minutes max.

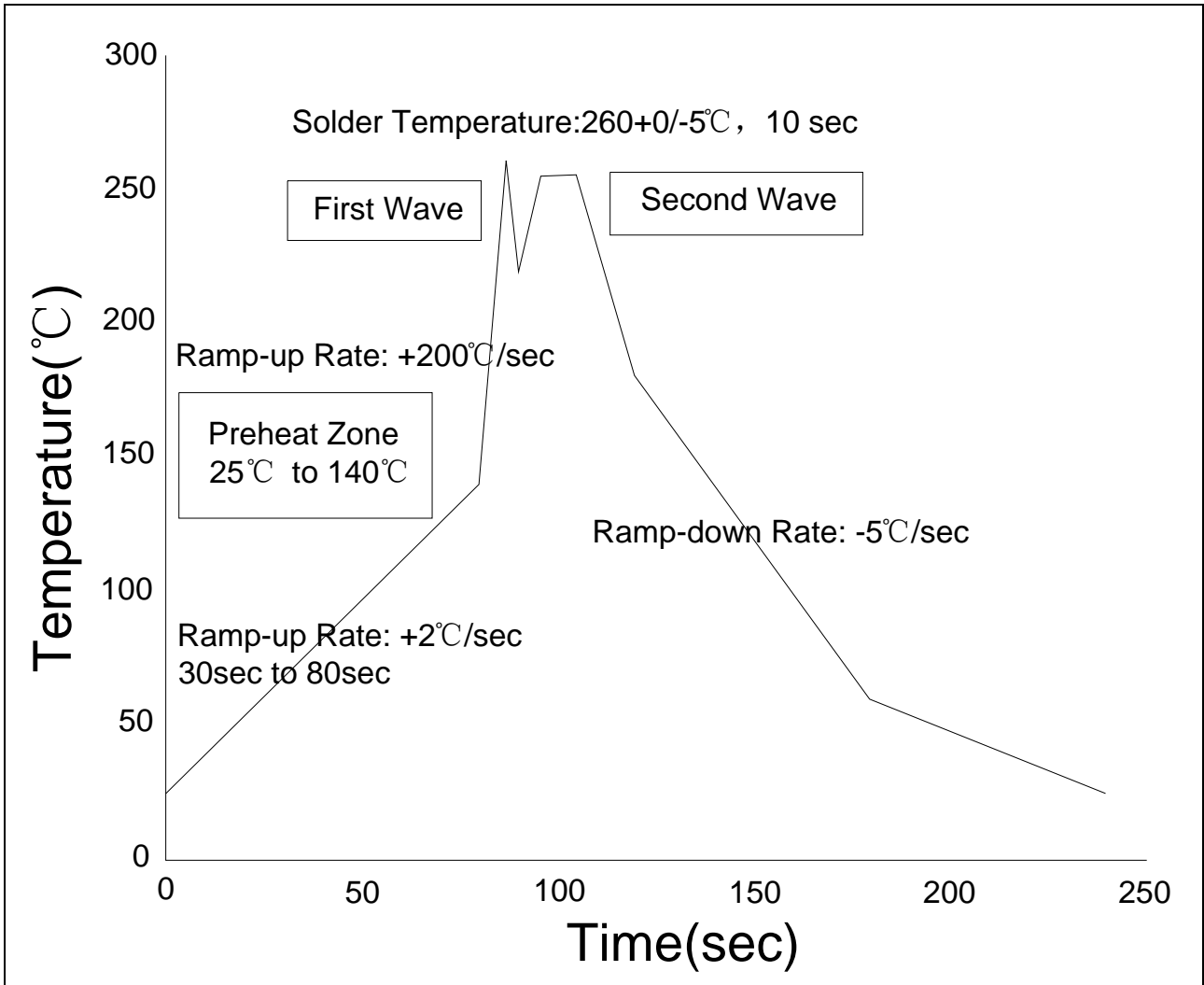

Soldering Temperature	360±5°C
Soldering Time	3s max.

Note:

1. Reflow soldering is recommended at the temperatures and times shown, no more than three times.
2. Avoid direct contact between the epoxy body and any tools or surfaces exceeding its maximum storage temperature.
3. Application of pressure on the epoxy body is prohibited at elevated temperatures. In specific scenarios, any applied force must not exceed 2.5N.
4. Ensure the component has cooled to ambient temperature before proceeding with any subsequent manufacturing steps.
5. The component has a shelf life of one year when stored under standard conditions.
6. Recommend storage Temp.: 0~40°C;
Recommend storage humidity: <60%;
MSL level: MSL 1

Information furnished in this document is believed to be accurate and reliable. However, Jiangsu JieJie Microelectronics Co., Ltd. assumes no responsibility for the consequences of use without consideration for such information nor use beyond it. Information mentioned in this document is subject to change without notice, apart from that when an agreement is signed, Jiangsu JieJie complies with the agreement.

Products and information provided in this document have no infringement of patents. Jiangsu JieJie assumes no responsibility for any infringement of other rights of third parties which may result from the use of such products and information. This document supersedes and replaces all information previously supplied.



is a registered trademark of Jiangsu JieJie Microelectronics Co., Ltd.

Copyright © 2026 Jiangsu JieJie Microelectronics Co., Ltd. All rights reserved.