

Parameter	Symbol	Value	Unit

Characteristics	Symbol	Min.	Typ.	Max.	Unit

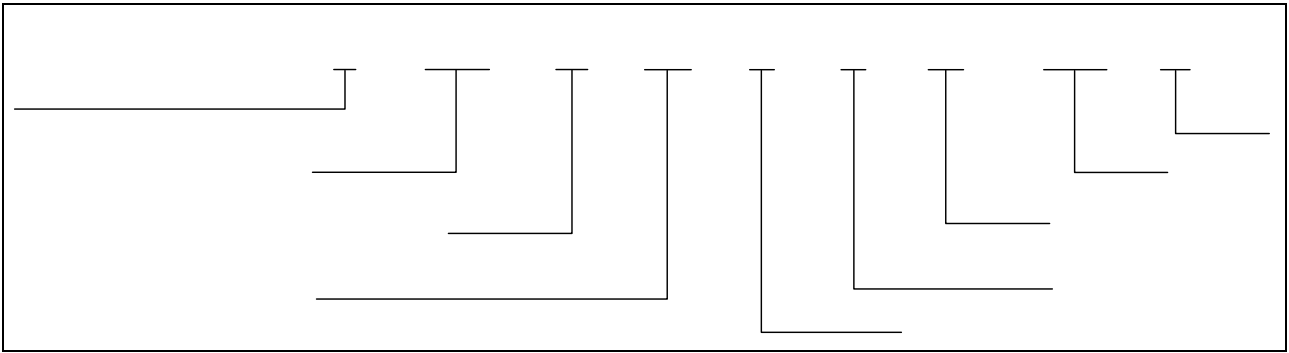

None/R	1200Units/Reel

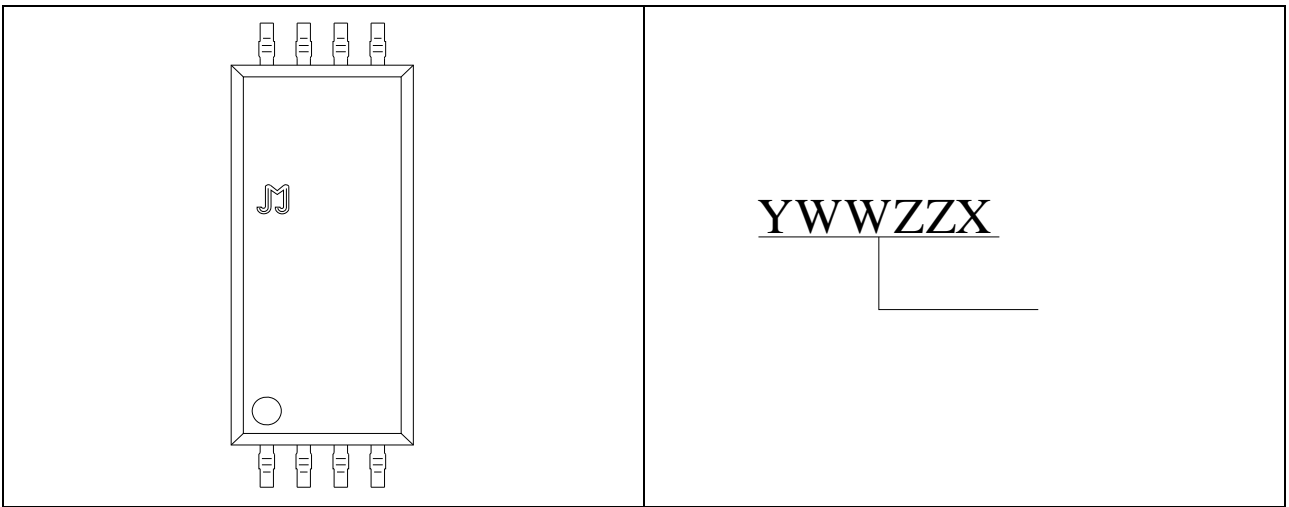

FIG.1:

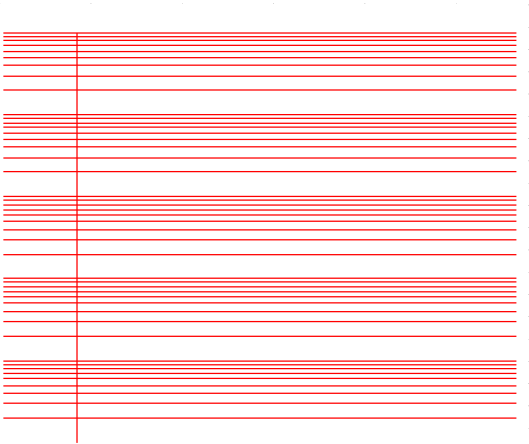

FIG.2:

FIG.7:

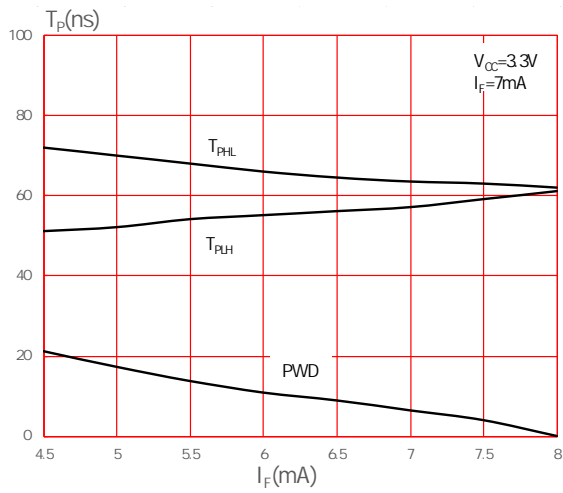

FIG.8:

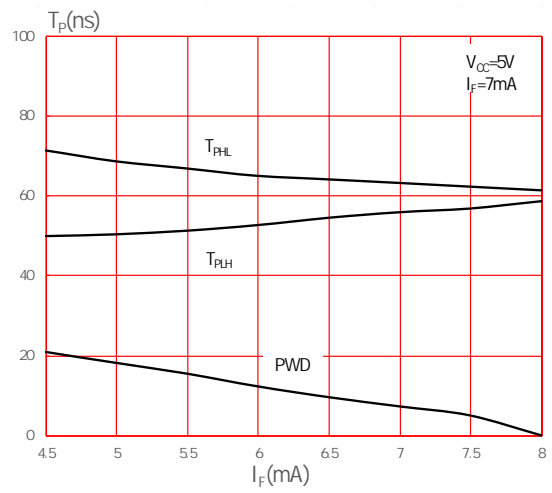

Fig.9: Test Circuits for TPHL, TPLH, tr, tf

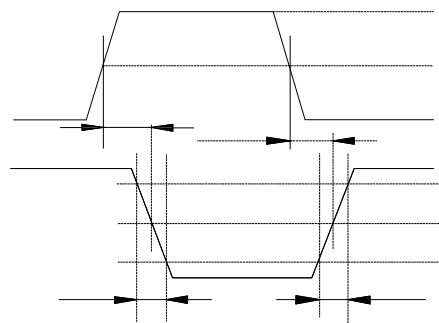
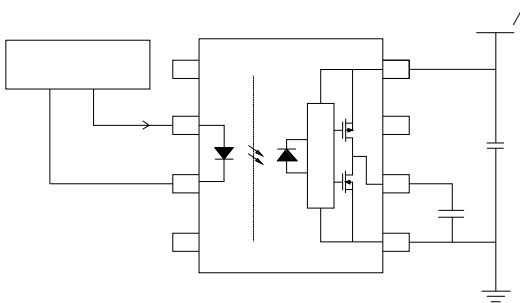

Fig.10: CMTI Test Circuit Recommendations

