



- , (- , (0 , & 5 2 (/ (& 7 5 2 1 , & 6 & 2 / 7

- 2 & ' \$ \$ % ' 3 6 6 H U L H V

5HY \$

^ Z / W d / K E W

7KH SURGXFWV DUH JDWH GULYHU RSWR FRXSOHUV LQ D SO
 ',3 SDFNDJH ZLWK GRUPLUQHJWSOHLRQV 7KH GHYLFH
 FRQVLVWV RI DQ LQFIDOOHGRXSBSW WR DQ LQWHJUDWHG
 KLJK JDLQ KLJK VSWHRC \$ & FWBSH,WHFURYLGHV
 JXDUDQWHHG SHUIRULPDDQVLRDQDQDWSWFIPISHUDWXUH XS
 WR ,W LV SK\VLFDQDQ\ VPDOOHU DQG FRPSOLDQW ZLWK LQ
 VDIHW\ VWDQGDUGHGVLIRUXDQVLRQF,W WKXV SURYLGHV D
 VPDOOHU IRRWSULQW VROXWLRQ IRU DSSOLFDWLRQV WKDW
 VWDQGDUG FHUWLILFDWLRQ \$Q LQWHUQDO QRLVH VKLHOG
 JXDUDQWHHG FRPPRQ FRXGLWUHQVLRQV L ,W
 LV LGHDO IRU VPDQG SDMMU 0*267(7 JDWH GULYH
 7KH SURGXFWV DUHQZLGHVU LQWHGQLYH\ WHUV , * % 7
 JDWH GULYHUV 028)(0 WDMQG & EWLQR FRRNWRSDQG
 KRPH DSSOLDQFHV

D / E & dhZ ^

+LJK LVRODWLRQ 9506
 %XIIHU ORJLF W\SH
 2SHUDWLQJ WHUPLSOJHDXJ& WR f &
 5(\$&+ 5R+6 FRPSOLDQFH
 +%0 + \$ 00 0 &'0 &
 &4& DSSURYHG
 9'(DSSURYHG
 8/ DSSURYHG

dOE μšZ d o

/(' 9&& 9(9&& 9(2XWSXW H (+60
 3RVLWLYH *RLQJHJDWLYH *RLQJ



^K>hd D y/DhD Z 7HP SHUDWXUH f&

3DUDPHWHU		6\PERO	9DOXH
/(')RUZDUG &XUUHQW)	
	3HDN)RUZDUG &XUUHQW	3	\$
	5HYHUVH 9ROWDJH	95	
	3RZHU 'LVVLSDWLRQ	3	P:
'HWHFWRU	2XWSXW 9ROWDJH	92	
	6XSSO\ 9ROWDJH	9&&	
	3RZHU 'LVVLSDWLRQ	3&	P:
,VRODWLRQ 9ROWDJH		9LVR	8 9UPV
2SHUDWLQJ 7HP SHUDWXUH		7RSU	a
-XQFWLRQ 7HP SHUDWXUH		7M	
6WRUDJH 7HP SHUDWXUH		7VWJ	a
7RWDO 3RZHU 'LVVLSDWLRQ		3WRW	P:
6ROGHULQJ 7HP SHUDWXUH		7VRO	

8 QL

EKd iiii • %oμo• U iiii, i (œ < μ v Ç
EKd i ()œ iu]vμš U ZX, XAđi• òi9

> dZ/ > , Z d Z/ 7HP SHUDWXUH f&

3DUDPHWHU		6\PERO	&RQGLWLRQ	0LQ	7\ S
,QSXW)RUZDUG 9ROWDJH))	9P\$		9
	5HYHUVH &XUUHQW ,5	5	9 9		\$
	7HUPLQDO &DSDFLWDQFH	7	1 0+&		S)
2XWSXW	3HDN +LJK OHYHO 2XWSXW &XUUHQW	23+	92 9&& 9 3XOVH ZLGWK" V		\$
			92 9&& 9 3XOVH ZLGWK" V		\$
	3HDN /RZ OHYHO 2XWSXW &XUUHQW	23/	92 9((9 3XOVH ZLGWK" V		\$
			92 9((9 3XOVH ZLGWK" V		\$
	+LJK /HYHO 6XSSO\ &XUUHQW	9&&) P\$ 92 2SHQ		P\$
	/RZ /HYHO 6XSSO\ &XUUHQW	9&&) P\$ 9&& 9		P\$

- 2 & ' \$ \$ %



- LH - LH 0LFURHOHFWURQL

&&

			9 ₂ 2 SHQ				
) P \$				
	+LJK /HYHO 2XW	SXW ₂ +9R	OWD JH 9	9			9
			2 P \$				
			9) 9				
	/RZ /HYHO 2XWSXW	9/ROWD JH	9 9				
			, ' AU Å" ' ,				



&RPPRQ 0RGH 7UDQVLHQW ,PPXQLW\ DW /RZ /HYHO 2XWSXW	9&& 9 7D 92 PD[9 9&0 9SS) P\$ “ “	N9 V
---	------------------------------------	--------------	------

o o d Ç%] o À î Ć μ • š d
 E}š W /v% μš •]Pv o ~ (Aîñl, ÌU μš Ç Añ]i • 9 b š • CEŠAZŠ (vA ññ • %o) CE ÁoZ } • Z X] v
 %o CE} v • š CE Ç Á] CE] vP %o]š v X
 E}š W ,D] • šZ u Æ] u μ u CE š } ((oo } (šZ } uu} v u μ • š Ā } yo š Ā] š Z
 šZ } μš %o μš Ā } oš P] v šZ Ú á } B } XZ] PZ • š š ~ sK
 E}š W D >] • šZ u Æ] u μ u CE š } (CE] • } (ššZ v } u u μ v š u] v Ā } š
 šZ } μš %o μš Ā } oš P] v šZ Ø ó š P X } o } Á • š š ~ sK

Z } uu v K% CE š] v P⁷⁸ } v] š] } v •

&KDUDFWHU LVWLFV 6\PERO 0LQ 7\S				
,QSXW 2Q VWDWH,) & X U UHQW				P\$
,QSXW 2II VWDWH) 9 R, O W DJ H 9				
6XSSO\ 9ROWDJH 9&&				9
2SHUDWLQJ)UHTXH QFV				N+]

E}š W dZ CE } uu v } %o CE š] v P } v] š] } v } CE P • Ā CE Ç • š } } š] P w
] v š v %o CE (} CE u v } (šZ Ā] X Z v %o v CE Ā u o š μ CE] z w] CE %o
 • Ç • š u •] P v μ •] v P ššZ] • o Ā] CE] u o Z • CE š] CE] } š] šZ] š • š } μ o o • }
 } v •] CE X
 E}š W CE u] %o] š } CE ~ i X í ... & • • Z } μ o s } v v v š %o] v š Ā ~ v E %o] š
 • š] o] šZ } %o CE B]] v p] v Z Ç P Z u %o o] (] CE X K šZ CE Ā] • U šZ] • %o Z
 %o CE } %o CE o Ç X dZ Ç] %o • • %o o] š } CE] šZ] v í %o] v X ()
 E}š W dZ CE] • v (oo š] u • } (šZ] v %o μ š Z } v r i X CE CE • v š • Z } μ o
 E}š W / (šZ CE] •] v P • o } %o } (šZ (} CE %o š Z o Ç Ā } o š } CE] • s • š %o U • š o
] v š CE v o] CE μ] š • v š v } š P μ CE š } • š i s l ... • } CE o • • X } CE CE] •
 E}š W v } š • šZ } %o CE } š] š šZ CE v P] u u v } %o] CE] š] X P }

- 2 & ' \$ \$ %



- LH-LH 0LFURHOHF WURQL

KZ Z/E' /E&KZD d/KE

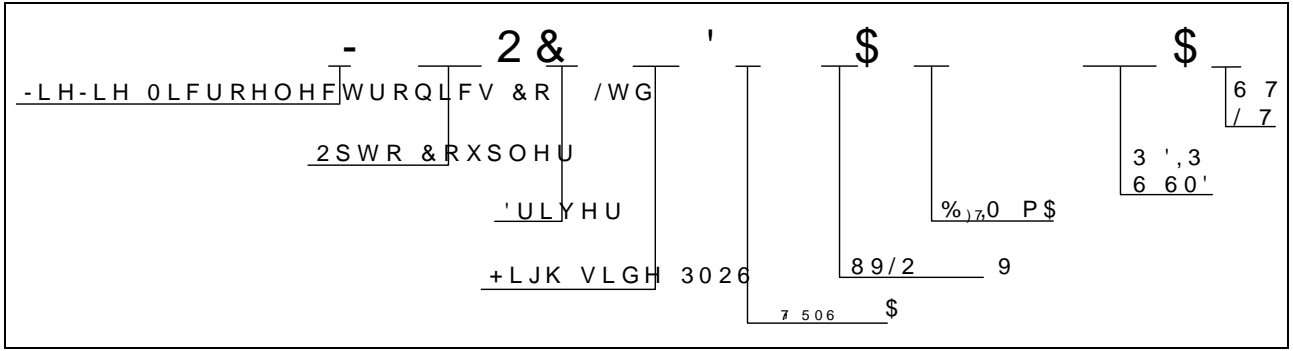

W I]vP Yμ vš]šÇ	
K% š]}v	Yμ vš]šÇ
/W	5ì hv]š•ldμ
^D	íîì hv]š•lZ o

D Z</E'

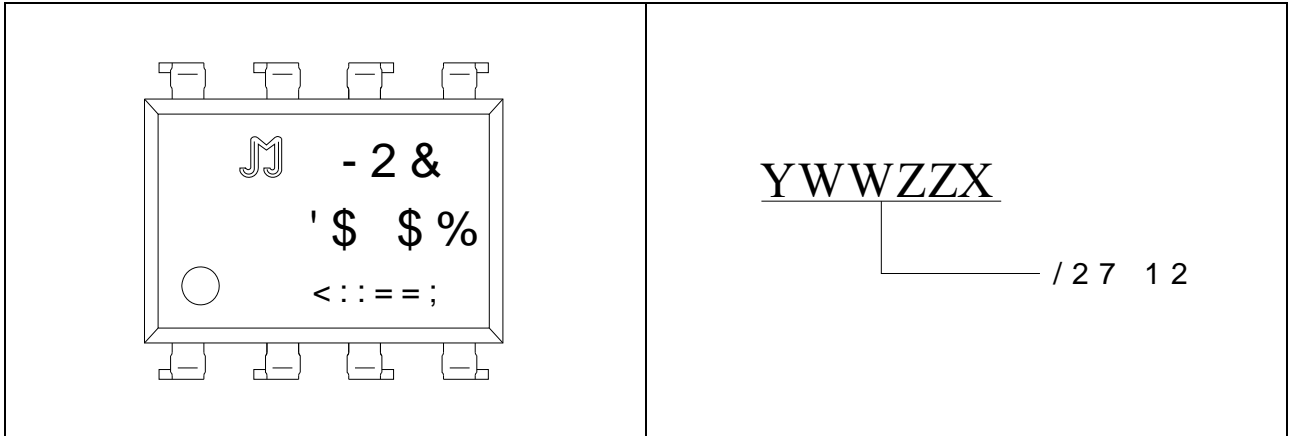



), * /RZ OHYHO 2XWSXW 9ROWDJH \$PELHQW, * +LJK OHYHOR 2XWSXW 9ROWDJH \$PELHQW 7HPSHUDWXUH

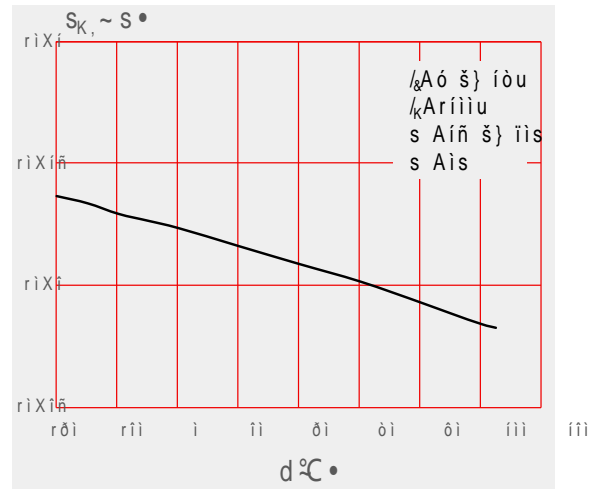
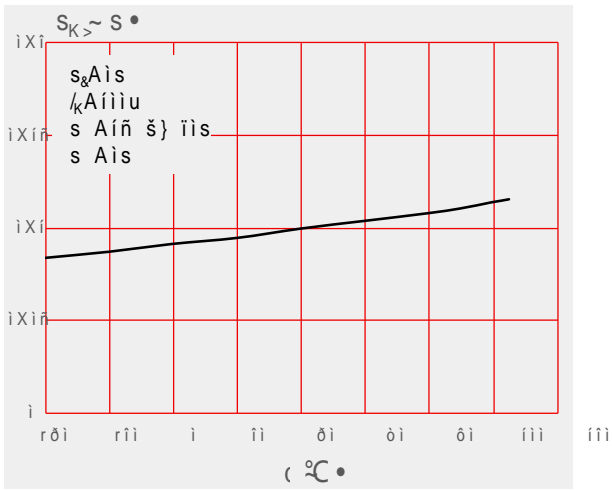

), * 3HDN /RZ OHYHO 2XWSXW &XUUHQW ¥LJKRZHYHO 2XWSXW 9ROWDJH OHYHO 2XWSXW 9ROWDJH \$PELHQW 7HPSHUDWXUH

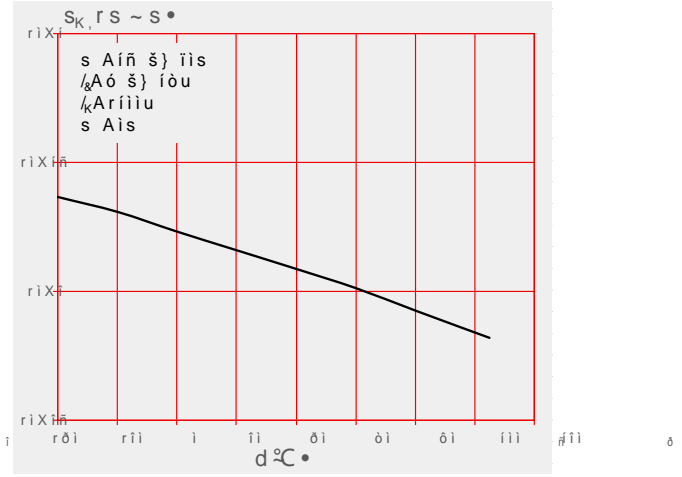
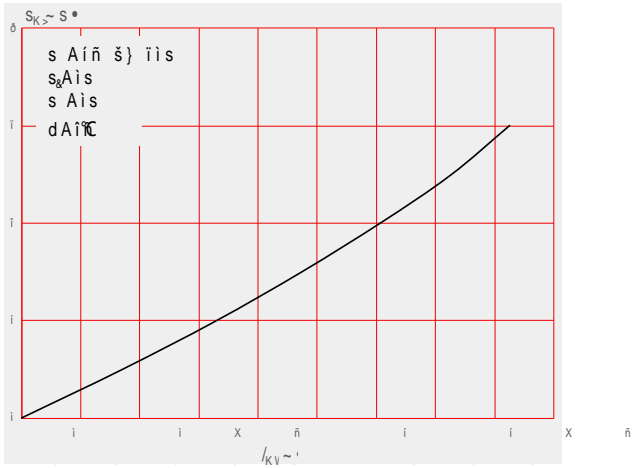

), * 3URSDJDWLRQ 'HOD\ 7LPH YV) \$PELHQW SDJDWLRQ 'HOD\ 7LPH YV &XUUHQW

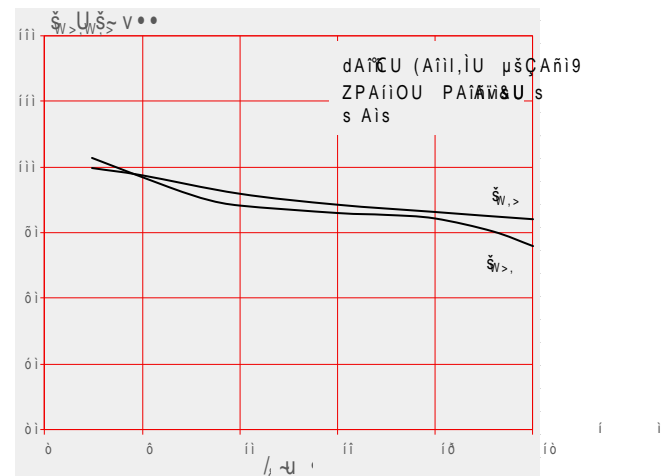
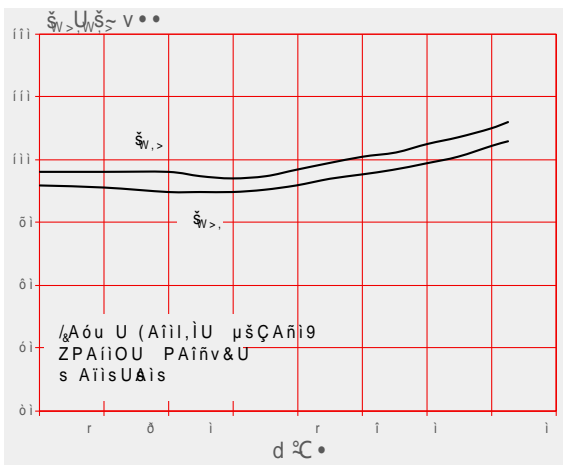

- 2 & ' \$ \$ %



W I P] u v •] } v ~ h v] š W u u •

6WDQGDUG ', 3 7\SH

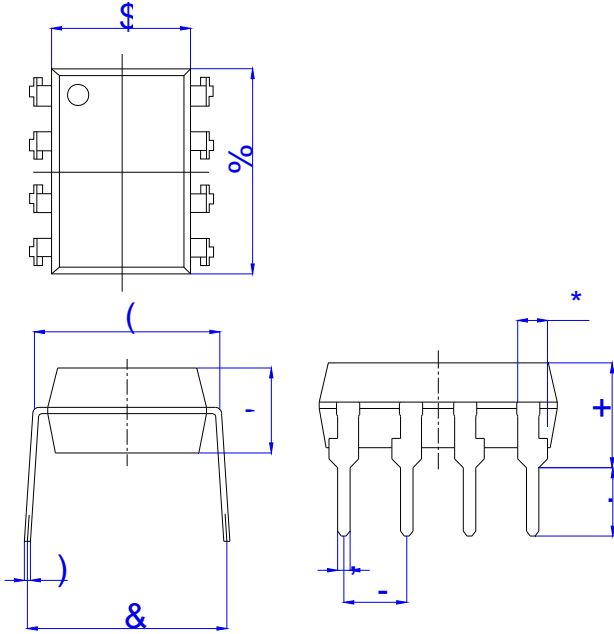

5HI	'LPHQVLRQV					
	0LOOLPHWHUV			,QFKHV		
	0LQ	7\S	0D[0LQ	7\S	0D[
\$						
%						
&						
'						
(
)						
*						
+						
,						
-						
.						

2SWLRQ 60' 7\SH

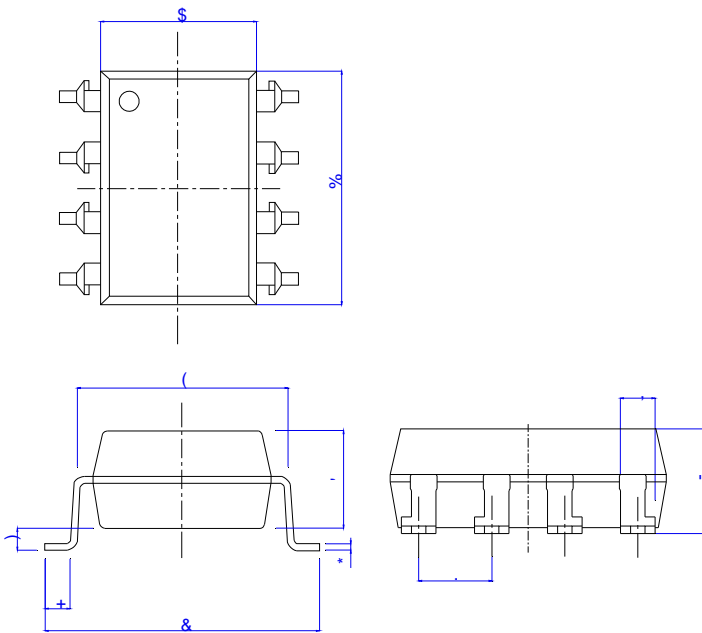

5HI	'LPHQVLRQV					
	0LOOLPHWHUV			,QFKHV		
	0LQ	7\S	0D[0LQ	7\S	0D[
\$						
%						
&						
'						
(
)						
*						
+						
,						
-						
.						



Z KDD E ^K> Z D ^< ~]u v•]}v•]v uu μvo •• }šZ Œ

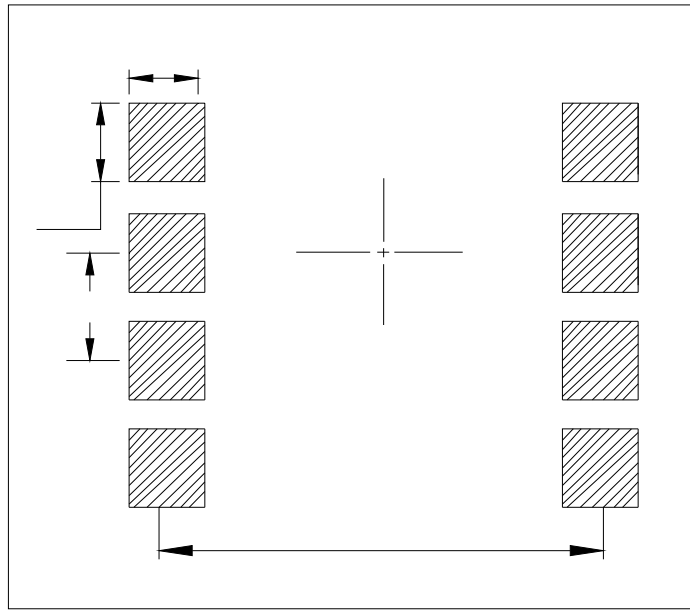

dh ^W /&/ d/KE^ ~]u v•]}v•]v uu μvo •• }šZ ŒÁ]•

6WDQGDUG ',3

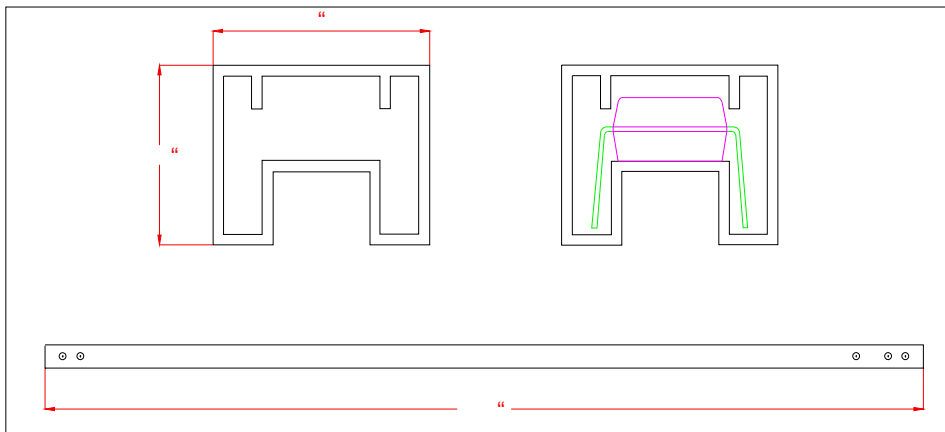



ZZ/ Z d W ^W /&/ d/|E^ }v]uu μvo •••ššž ĆÁ]•

2SWLRQ 6 /

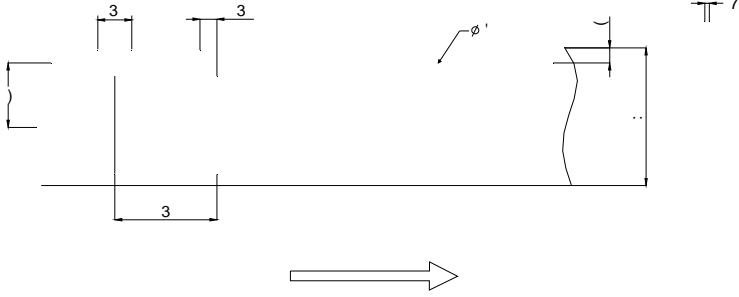

5 HI	'LPHQVLRQV					
	0LOOLPHWHUV			,QFKHV		
	0LQ	7\S	0D[0LQ	7\S	0D[
,						
3						
3						
3						
(
)						
7						
:						



Z & >Kt /E&KZD d/KE

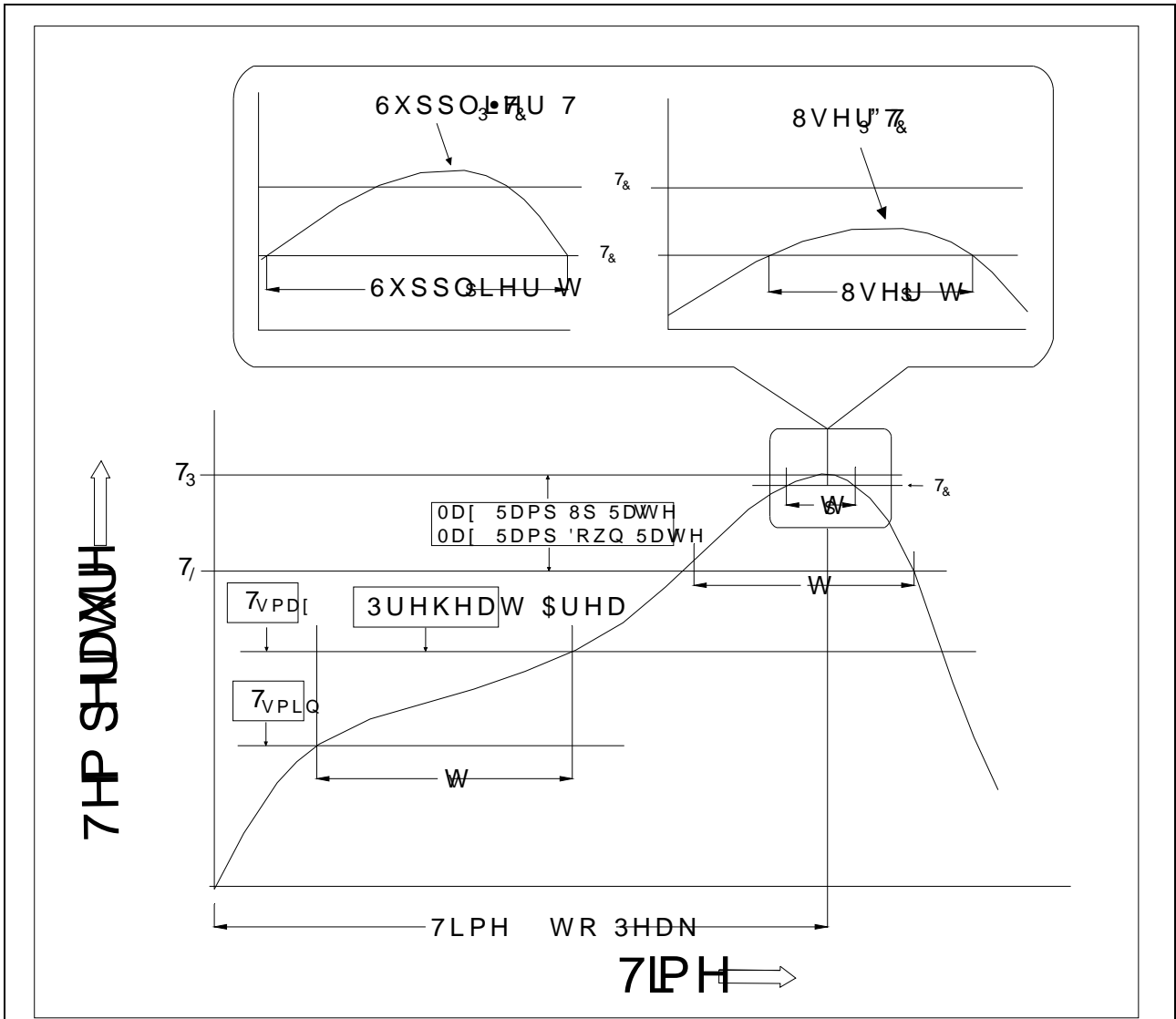

3URILOH)HDWXUH Q 3E \$VVHPEO\	3URILOH 3E)UHH \$VVH
7HP SHUDWXUH 0LQ 7VPLQ	
7HP SHUDWXUH 0D[7VPD[
7LPH WV IURP 7VPLQ WR 7VPD[VHFRQG V
5DPS XS 5DWH W/ WR W VHFRQG PD[VHFRQG PD[
/LTXLGXV 7HP SHUDWXUH 7/	
7LPH W/ 0DLQWDLQH \$ERYH 7/	VHFRQG V
3HDN %RG\ 3DFNDJH 7HP SHUDWXUH	
7LPH W3 ZLWKLQ	VHFRQG V
5DPS GRZQ 5DWH 73 WR VHFRQG PD[VHFRQG PD[
7LPH WR 3HDN 7HP SHUDWXUH	PLQXW V HV PD[



t s ^K> Z/E'

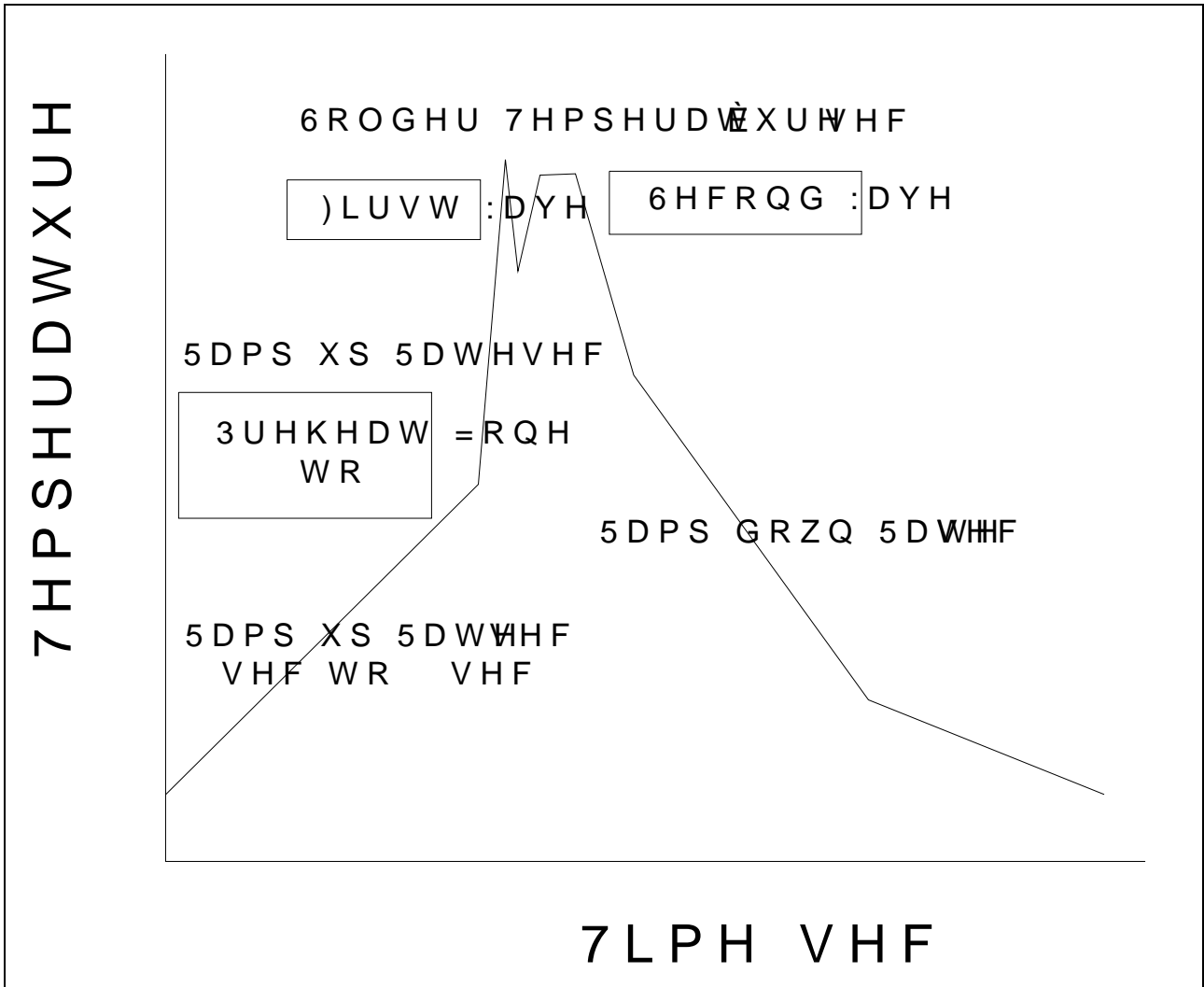

, E ^K> Z/E' z ^K> Z/E' /ZKE

6ROGHULQJ 7HPSHUDWXUH	f
6ROGHULQJ 7LPH	V PD[

- 2 & ' \$ \$ %



- LH - LH 0LFURHOHFWURQL

1RWH

5HIORZ VROGHULQJ LV UHFRPPHQGHG/ DWKRVZQH QVHPSHUDWXDQ WBO
\$YRLG GLUHFV FRQVWDH SVRPHQVZDQ QWRXUDFRU H[FHHGLQJ LWV PD
VWRUDJH WHPSHUDWXUH
\$SSOLFDWLRQ RKHSHSRVXENRQLWLSOHGDDWHG WAPSHUDWXUDWOP, QFM